



**Digifant I**

**Digifant II**

**ProTraining**

Provided By Thunder

**DIGIFANT II**  
**System Components/Operation**

System Description	1
Electronic Control Unit (E.C.U.)	2
Power Supply Relay/Fuel Pump Relay	3
Fuel Delivery System	4
Fuel Injector Assembly	5
Fuel Pressure Regulator	6
Fuel Injector	6
Air Filter Housing/Intake Air Preheating	7
Air Flow Sensor	8
Intake Air Temperature Sensor	8
Throttle Switches	9
Coolant Temperature Sensor	10
Oxygen Sensor	10
Ignition System	11
Knock Sensor	12
Knock Sensor Regulation	13
Ignition Distributor	13
Idle Stabilization	14
Crankcase Control Valve	16
Evaporative Emission System	16
Vacuum Hose Layout/Vacuum Amplifier	17
On Board Diagnosis System (California Only)	54

**Checking/Adjusting**

Throttle Valve	18
Throttle Switches, Checking/Adjusting	19
Throttle Switches, Checking Voltage Supply	21
Coolant Temperature Sensor	22
Air Flow Sensor/Intake Air Temperature Sensor	23
Fuel Injectors, Electrical Checks	24
Fuel Injectors (Spray Pattern, Quantity, Leak Testing)	26
Deceleration Fuel Cut-Off	28
Full Throttle Enrichment	29
Oxygen Sensor System	30
Fuel Pumps (Electrical)	32
Fuel Pumps (Current Draw, Delivery Rate)	35
Fuel Pressure/Residual Fuel Pressure	37
Ignition System	39
Knock Sensor	41
Idle Stabilization	42
Evaporative Emission System	44
Intake Air Preheating	46

**Basic Engine Adjustments**

Ignition Timing, Idle Speed, CO Content	48
---	----

**System Check With Volt/Ohmmeter**

System Test Chart	52
-------------------	----

**Functioning Wiring Diagram**

Golf	58
Jetta	60
Special Tools Required	62
Glossary/Component Location	63

# General Troubleshooting Guidelines

Fuel systems can be repaired by following the step-by-step procedures shown in this book.

## Make Sure You Understand The Customer's Complaint

- Identify the symptoms as you follow the diagnosis procedure. Try to determine the cause of the problem.
- Repair the problem after you have identified the symptoms.
- After completing repairs, always road test the vehicle before returning it to the customer.

## Preliminary Checks

A complaint may be caused by a minor detail. Before starting the fault finding procedure, make a few visual checks, such as:

- Are all electrical connections clean and tight? Spark plug wires not hanging loose, etc.
- Are all hoses OK? Check vacuum, crankcase ventilation, fuel tank ventilation, and air intake hoses for restrictions, cracks, or looseness.
- Are all the ground connections OK?
- Is there adequate fuel supply?

## Pinpointing The Problem

### Remember the basics:

- No matter how advanced the system, to start and run an engine you need correct spark timing, and the proper fuel-to-air ratio.
- Get as much information as possible from the customer.
- Gather as many symptoms as possible.
- Check the simple things first.
  - **Look** for spark.
  - **Listen** for the fuel pump.
  - **Feel** the injectors operating.
- **Make logical deductions, not assumptions.**

## Intermittent Engine Performance Complaints

Intermittent performance complaints can be caused by any part of the electrical, ignition, or fuel systems. Therefore, obtain as much information as possible from the customer. Find out under what conditions the problem occurs, how often, and for what duration. For example: engine cold?, during warm-up?, under load?, light acceleration?, highway driving?, only in hot weather?, only at high altitude?, etc.... If possible, road test the vehicle to duplicate the condition.

When troubleshooting intermittent engine performance complaints:

- Pay very close attention to electrical connections on the fuel injection harness. Connectors which have insufficient tension, are bent, or show signs of corrosion **should be replaced and not repaired.**
- Corroded and/or loose ground connections should be cleaned and tightened.
- The complete fuel system should be checked, including the fuel quality.

# General Troubleshooting Guidelines

## • Engine will not start, hot or cold

- a. No fuel
  - Page 32 Fuel System (Circuit Tests)
  - Page 24 Injectors (Circuit Tests)
  - Page 23 Air Flow Sensor
- b. No spark
  - Page 39 Ignition System

## • Hard starting, hot or cold

- a. Insufficient or excessive fuel
  - Page 22 Coolant Temperature Sensor
  - Page 32 Fuel System
  - Page 37 Residual Pressure Test
  - Page 44 Evaporative Emission System
- b. Weak or no spark
  - Page 39 Ignition System

## • Poor idle

- a. At operating temperature
  - Page 19 Throttle Switch
  - Page 42 Idle Stabilization System
  - Page 44 Evaporative Emission System
  - Page 46 Intake Air Preheating
- b. Cold engine
  - Page 22 Coolant Temperature Sensor
  - Page 42 Idle Stabilization System
  - Page 46 Intake Air Preheating

## • Engine stalls at highway speeds

- a.
  - Page 26 Fuel System (Pressure, Volume, Current Draw)
  - Page 44 Evaporative Emission System
  - Page 48 Basic Engine Adjustments
  - Page 52 Ground and Terminal Connections



# General Troubleshooting Guidelines

## • Poor performance

- a. During warm-up
  - Page 48 Basic Engine Adjustments
  - Page 22 Coolant Temperature Sensor
  - Page 19 Throttle Switch
  - Page 42 Idle Stabilization System
  - Page 46 Intake Air Preheating
- b. At operating temperature
  - Page 48 Basic Engine Adjustments
  - Page 19 Throttle Switch
  - Page 41 Knock Sensor
  - Page 30 Oxygen Sensor System
  - Page 39 Ignition System
  - Page 26 Fuel System (Pressure, Volume, Current Draw)
  - Page 42 Idle Stabilization System
  - Page 46 Intake Air Preheating
- c. At full throttle
  - Page 29 Full Throttle Enrichment
  - Page 41 Knock Sensor
  - Page 39 Ignition System

## • High fuel consumption

- Page 30 Oxygen Sensor System
- Page 35 Fuel System (Pressure, Volume Tests)
- Page 26 Fuel Injectors (Spray Pattern, Leakage)
- Page 29 Full Throttle Enrichment
- Page 44 Evaporative Emission System (Leakage)

### Note:

Driveability problems that occur even when all engine specifications are in order may be caused by injector tip gum-up or carbon build-up on the intake valves and injector tips. These deposits are related to the use of gasoline with insufficient cleaning additives and can be prevented by:

- Using only major brand gasolines that advertise their additive packages are effective for cleaning fuel injection systems.
- Avoiding fuels that contain alcohol.
- Regular use of supplemental additives such as Autobahn Fuel Additive, which is

specifically formulated to prevent carbon, gum or varnish build-up and help break down existing deposits.

Once formed, many deposits cannot be removed by normal preventative measures such as the use of fuel additives. Most injector deposits can be removed by using a special cleaning system like our G-16 Fuel Injection System Cleaner. Carbon build-up may require mechanical removal.

Check Group 24 of your Technical Information Book for further information on injection system cleaning and de-carbonization.

# System Components/Operation

## Digifant II Engine Management System

Digifant II is a further development of the Digifant I system currently used on the Vanagon. The new Digifant II system uses a knock sensor, and has the idle stabilization circuitry incorporated in the Electronic Control Unit. Unlike Digifant I, the Hall control unit is mounted externally on the Digifant II E.C.U.

Through the use of sophisticated electronic controls, all functions of the fuel and ignition systems are carefully controlled throughout the entire range of engine speed, engine load, and temperature conditions to provide a fuel efficient engine with maximum performance.

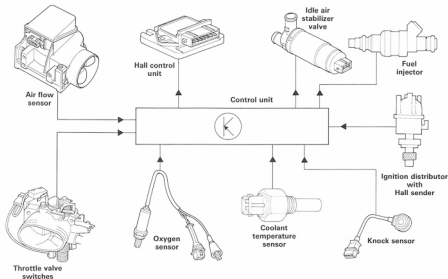

# System Components/Operation

## Electronic Control Unit (E.C.U.)

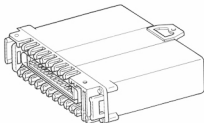

The E.C.U. is located in the engine compartment on the left side (driver's side) plenum

The heart of the Digifant II system is the new electronic control unit. The control unit incorporates all the functions of the fuel system and provides both the actuation signal for the fuel injectors and optimum ignition timing point for all engine operating conditions.

The E.C.U. receives seven major input signals:

- **Engine speed:**  
From the Hall sending unit.
- **Engine load:**  
From the intake air volume.
- **Intake air temperature:**  
From the air flow sensor temp. sensor.
- **Engine operating temperature:**  
From the coolant temperature sensor.
- **Throttle position:**  
From the throttle switches.

- **Oxygen content in the exhaust gas:**  
From the oxygen sensor.
- **Spark knock threshold for the ignition timing:**  
From the knock sensor.

Based on the information received from these seven major inputs, the Digifant E.C.U. generates the three major output signals necessary to control engine operation under all conditions. The Digifant E.C.U. also controls the ground circuit for the fuel pump relay so the pumps run only when an RPM signal is present.

Fail-safe functions are programmed into the control unit memory so the system will continue to operate in the event of a fault in the coolant temperature sensor, oxygen sensor or knock sensor.

# System Components/Operation

## Digifant Electronic Control Unit — E.C.U. (Cont'd.)

The Digifant E.C.U. generates the following three output signals:

- Ground signal for the fuel injectors. This signal controls the amount of fuel injected into the engine by regulating the length of time the injectors remain open. Cold start enrichment, warm-up enrichment, full throttle enrichment, fuel cut-off on deceleration, and fuel cut-off on over-rev (over 6500 RPM) are all controlled by regulating the ground for the fuel injectors.
- Trigger signal for the ignition coil. This controls the exact moment the ignition coil fires each cylinder to ensure precise ignition timing under all operating conditions. The Digifant E.C.U. monitors engine speed, engine load, coolant temperature, and intake air temperature, then selects the optimum ignition timing point from an internal timing "map." The knock sensor allows the Digifant E.C.U. to maintain ignition timing as advanced as possible for good performance while eliminating the possibility of detonation or spark knock.

- Control current for the idle stabilizer. This regulates the opening and closing of the idle stabilizer valve to control the amount of idle air that bypasses the throttle plate. If the idle speed varies from the value stored in the E.C.U., it compensates by opening or closing the stabilizer valve.

The E.C.U. also receives a signal when the A/C compressor clutch is activated. The E.C.U. increases control current by a predetermined amount when the A/C clutch is activated. This prevents a severe idle speed dip before the idle stabilization system can compensate. The current increase remains effective for as long as the compressor clutch is engaged.

The control current output also increases idle speed during warm-up enrichment and for a short period following a hot start at high outside temperatures.

## Power Supply/Fuel Pump Relay

### Power Supply Relay

Provides battery voltage to the E.C.U. in the Golf. Provides battery voltage to the E.C.U. AND the fuel injectors in the Jetta.

### Fuel Pump Relay

Provides battery voltage to the fuel pumps and fuel injectors in the Golf. Provides battery voltage to the fuel pumps and oxygen sensor heating element in the Jetta.

**Note:**

These relay locations are valid for vehicles produced before January 1989.

### Relay Location

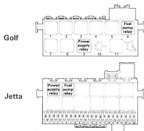

# System Components/Operation

## Fuel Delivery System

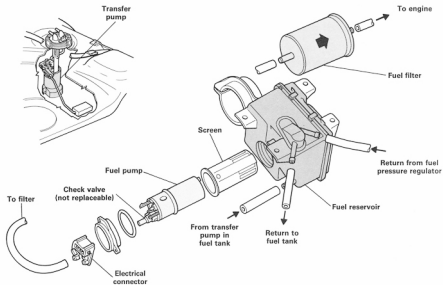

The Digifant II fuel delivery system is similar to that used on the Golf and Jetta with CIS-E. However, the fuel pump pressure is reduced, and the fuel accumulator has been eliminated.

The fuel pump is a roller cell design and is cooled and lubricated by the fuel flowing through it. The fuel pump has a check valve on the output side to help maintain residual pressure when the pump has been shut off.

The fuel pressure regulator has a check valve as well which also aids in maintaining residual pressure.

The transfer pump in the fuel tank which supplies fuel to the reservoir is the same as used in the CIS-E fuel system.

The fuel filter is a lifetime fuel filter and does not need replacing unless contaminated.

# System Components/Operation

## Fuel Injector Assembly

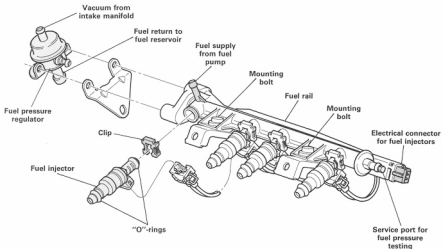

The Digifant II fuel injector assembly includes: injectors, fuel pressure regulator, service port for fuel pressure testing, and injector wiring harness.

The complete assembly can be removed by removing the Allen head mounting bolts. The injectors can be separated from the fuel rail by removing the "U"-shaped clip.

The plastic injector inserts in the cylinder head have been changed to accept the new style injector. A 10 mm wrench is needed to remove and install the inserts. When installing the inserts into the cylinder head, use D-6 sealing compound.

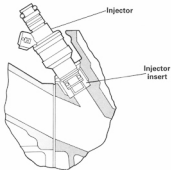

# System Components/Operation

## Fuel Pressure Regulator

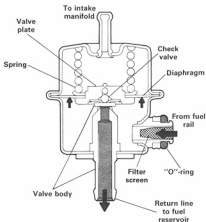

The fuel pressure regulator maintains approximately 2.5 bar of pressure at idle and up to 3.0 bar when the engine is under load. This is done by regulating the amount of fuel that is returned to the reservoir.

The regulator mounts to the fuel injector assembly. A small filter screen is installed in the inlet of the regulator. The regulator has a vacuum hose that is connected to the intake manifold. The amount of vacuum supplied to the regulator helps control the amount of fuel that is returned to the fuel reservoir by moving the diaphragm inside the regulator. When the engine is shut off, the check valve closes and seals to maintain residual fuel pressure for restarting.

## Fuel Injector

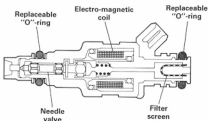

Digifant II fuel injectors are electronically controlled on/off valves. A solenoid actuates a needle valve allowing fuel to be forced through the injector nozzle. All four injectors open at the same time and inject fuel directly into the intake manifold near the intake valve. Injection quantity is controlled by the amount of time the injectors stay open. Injector opening time is regulated by the E.C.U., based on inputs from the various engine sensors.

The E.C.U. grounds the injectors to control opening time. Internal resistance of each injector is approximately 14-18 ohms. When checking all four injectors, the resistance will be approximately 3.7-5.0 ohms.

# System Components/Operation

## Air Filter Housing

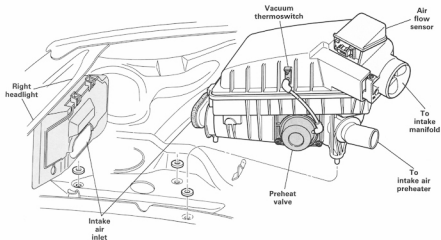

Air is drawn into the air filter housing from behind the right headlight. The intake air muffler, which was located in the front right fender, has been eliminated.

This system is equipped with a vacuum operated preheat valve for regulating intake air temperature. The preheat valve is located on the air filter housing.

The preheat valve is controlled by a vacuum thermostitch. The thermostitch senses intake air temperature and controls the amount of vacuum to the preheat valve. The preheat valve regulates the amount of preheated air that enters the intake manifold.

The air flow sensor is bolted to the air filter housing.



# System Components/Operation

## Air Flow Sensor

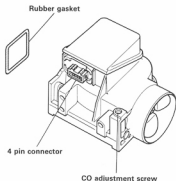

The air flow sensor measures the amount of air entering the intake manifold and sends a voltage signal to the control unit.

Intake air opens the air flow sensor flap which actuates the potentiometer to determine the voltage signal. This signal and the engine speed information supplied by the Hall sender are used as the principal inputs for the determination of fuel injector opening duration and ignition timing points.

A compensation flap connected to the air sensor dampens sudden movements of the air sensor flap due to oscillations of the intake air.

## Intake Air Temperature Sensor

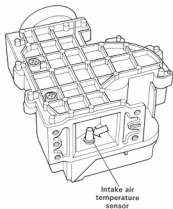

An intake air temperature sensor is mounted in the air flow sensor housing. It is a negative temperature coefficient (NTC) resistor, which means its resistance value drops as its temperature increases. The signal it supplies to the control unit is used to modify fuel injection rate depending on intake air temperature. The sensor can be tested by measuring the resistance value of the sensor and comparing the reading to a graph.

# System Components/Operation

## Throttle Switches

The idle and full throttle switches are wired in parallel. The switches are mounted on the throttle housing.

A voltage signal is sent to the E.C.U. when the throttle switch and throttle plates are closed. The switch opens when the throttle has been opened approximately 1°. The idle switch signal is used for:

- Operation of idle stabilizer valve
- Operation of deceleration fuel shut-off
- Activation of special ignition timing map for deceleration

The full throttle switch closes about 10° before full throttle. This signal is used for:

- Full throttle enrichment

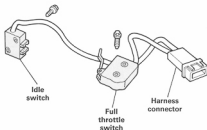
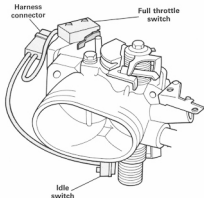

# System Components/Operation

## Coolant Temperature Sensor



The coolant temperature sensor is also a negative temperature coefficient resistor (NTC). The resistance signal it produces is used by the control unit to determine cold start enrichment. It also provides a signal to continue to enrich the mixture during engine warm up.

The signals from this sensor also provide correction to ignition timing based on engine temperature.

If the coolant temperature sensor is disconnected while the engine is running, the oxygen sensor system will go into open-loop operation.

## Oxygen Sensor

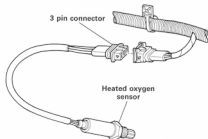
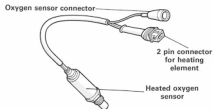

With Digifant II, a separate control unit and frequency valve are not needed. The sensor is connected directly to the Digifant II E.C.U. The control unit uses the voltage signal from the oxygen sensor and adjusts the opening time of the injectors to maintain proper air/fuel mixture.

Digifant II vehicles use a heated oxygen sensor. The sensor is located:

- In the exhaust manifold of the 100 HP engine.
- In the front of the catalytic converter on the 105 HP engine.

Replacement interval for the oxygen sensor is 60,000 miles. A mileage counter and oxygen sensor warning light are no longer used.

# System Components/Operation

## Ignition System

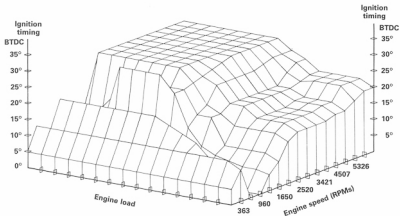

The ignition system operates on the principle of a timing map programmed into the E.C.U. Information on engine load, speed and coolant temperature are provided to the E.C.U. in the form of voltage signals. In the E.C.U., these signals are processed so that the ignition coil is controlled via terminal 1 in accordance with the programmed ignition map.

An engine speed signal comes from the Hall sender in the distributor, and measurement of engine load is accomplished through a signal from the air sensor potentiometer. These two signals establish the ignition timing point. They are stored in the ignition map in the control unit's memory as 256 single operational points, 16 fixed points for each engine load point and 16 for each RPM point.

The engine coolant temperature sensor signals the control unit to correct the ignition timing based on engine temperature. Throughout the engine warm-up phase, ignition timing is constantly being corrected.

Once the engine reaches operating temperature, the timing is determined by the map shown.

Ignition timing is also corrected through the use of a knock sensor.

# System Components/Operation

## Knock Sensor

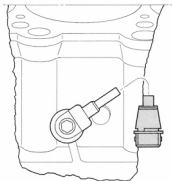

The knock sensor is attached to the left side of the cylinder block next to cylinder #2. It is a piezoelectric crystal encased in a metal and plastic housing.

Vibrations in the engine will cause the quartz crystal in the knock sensor to generate a small voltage. By monitoring this voltage, the ignition control unit can determine when ignition knock or detonation occurs. The ignition control unit will then retard the ignition timing to prevent the ignition knock.

The construction of the knock sensor is slightly different than previous versions. A steel bushing is located inside the sensor housing. This is to prevent the quartz crystal inside the sensor from being crushed or damaged by overtightening the installation bolt.

The torque for the knock sensor bolt is:

- 20-25 Nm (15-18 ft.-lbs.)

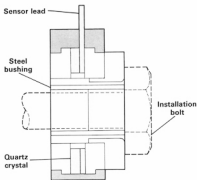

# System Components/Operation

## Knock Sensor Regulation

If a cylinder develops ignition knock, the Digifant II control unit will sense this through the knock sensor mounted on the engine block. The control unit will then retard the ignition timing  $3.0^\circ$  for that cylinder. If the knocking stops, the ignition timing will be advanced in steps of  $0.33^\circ$  back to the pre-programmed value.

If the knocking continues or recurs, the ignition timing can be retarded up to  $15^\circ$  for each cylinder. The difference between two cylinders is limited to  $9^\circ$ .

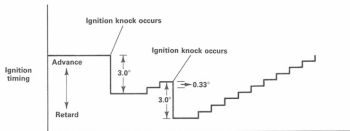

## Ignition Distributor

The ignition distributor has no centrifugal or vacuum advance. It contains a Hall sender which is operated by a trigger wheel. The trigger wheel has four apertures, one for each cylinder.

The Hall sender sends a voltage signal to the E.C.U. for each cylinder. From this signal, the control unit determines engine speed and crankshaft position.

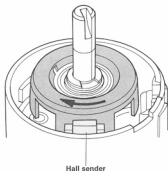

# System Components/Operation

## Idle Stabilization

The idle stabilization system used on the Digifant II system insures that the idle speed remains constant at predetermined levels. The system controls the amount of air bypassing the throttle plate.

If engine idle speed varies from the value stored in the control unit, the idle stabilizer valve will adjust the volume of air entering the engine at idle. This maintains idle speed within certain limits.

The idle stabilizer is operated by the E.C.U. The E.C.U. receives inputs from the following components:

- Idle switch
- Coolant temperature sensor
- A/C compressor clutch
- Hall sender

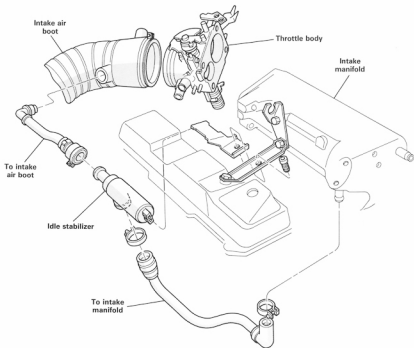

# System Components/Operation

## Idle Stabilization (Cont'd.)

The Digifant II E.C.U. supplies the idle stabilizer with approximately 400 mA of current at idle. This current is passed through a set of electrical windings inside the valve. This creates a magnetic field that regulates the position of the valve plunger.

If the idle speed varies from the specifications programmed into the Digifant E.C.U., the control current to the idle stabilizer is increased or decreased to maintain the correct idle speed.

If the idle speed drops below specification, such as a drop caused by power steering load, the current to the idle stabilizer is increased. This opens the valve plunger farther, allowing more air to bypass the throttle plate and increase the idle speed to within specifications.

The control current may fluctuate between approximately 380 mA to 1000 mA due to the following conditions:

- The engine is cold.
- The power steering is turned fully to lock.
- The automatic transmission is in gear.
- Electrical consumers such as headlights, coolant fan, etc. are operating.

In addition to the normal fluctuations caused by these conditions, the stabilizer current is increased by a pre-set value whenever the A/C compressor clutch is engaged.

If a fault develops in the coolant temperature sensor circuits, or when the sensor is disconnected for basic engine adjustments, the Digifant E.C.U. delivers a default value of approximately 430 mA to the stabilizer.

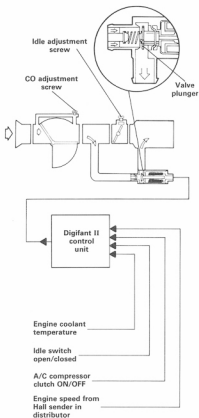



# Checking/Adjusting

## Crankcase Control Valve

The crankcase emission control system is a closed system. Therefore, no crankcase emissions are discharged into the atmosphere.

The control valve allows crankcase emissions to enter the intake air boot any time the engine is running to help control crankcase pressure.

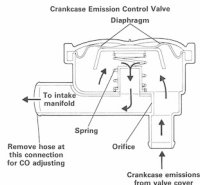

When checking or adjusting CO content, the hose from the crankcase emission control valve to the intake manifold is disconnected and plugged. The crankcase vapors vent to atmosphere during adjustment.

## Evaporative Emission System

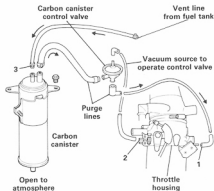

The carbon canister stores fuel vapors from the fuel tank when the engine is off. During normal driving, fuel tank vapors are drawn into the throttle housing via the carbon canister control valve.

The illustration (left) shows the flow of fuel tank vapors with the throttle open (vacuum supplied to the control valve). The vapors are drawn into the throttle housing via a 1.2 mm orifice (restrictor).

The vacuum source for the control valve is before the throttle plate. This means that when the throttle is closed, the carbon canister is not purged. Therefore, when setting CO%, it is not necessary to disconnect the carbon canister vent line.

# System Components/Operation

## Vacuum Hose Layout Manual Transmission

**Caution:** It is important that these two vacuum hoses are not reversed.

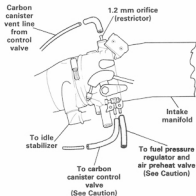

## Vacuum Hose Layout Automatic Transmission

Vehicles with the Digifant II fuel system equipped with an automatic transmission use a vacuum amplifier. The purpose of the amplifier is to increase vacuum to the brake booster at idle.

On both automatic and manual transmission equipped vehicles, the carbon canister vent line is **not** disconnected when checking or adjusting CO content.

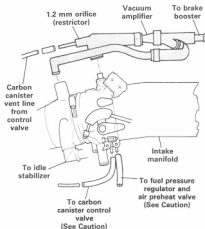

# Checking/Adjusting

## Throttle Valve — Basic Adjustment

### Note:

The stop screw is set at the factory and should not be moved. If the screw position has been altered, check basic adjustment as follows:

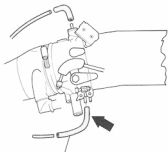

To carbon canister control valve

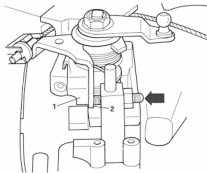

- Remove vacuum line from purge control fitting of the throttle valve (Arrow).
- Install vacuum pump US 8026 or equivalent vacuum gauge to fitting.
- Start engine and let idle.
- At idle, the vacuum should be 0 in. Hg. (up to 1 in. Hg. is acceptable).

If there is 1 in. Hg. or more vacuum, or if the tamper proof paint on the throttle stop screw is broken, adjust the throttle valve as follows:

- Turn the throttle stop screw (Arrow) **out** until a gap exists between lever 1 and lever 2.
- Place a piece of paper between the two levers.
- Turn the screw **in** until you feel a very slight drag on the paper.
- Turn the stop screw **in** an additional 1/2 turn.
- Repeat the vacuum test at the purge fitting.

If the vacuum reading is **OK**,

- Re-apply paint to the stop screw.
- Check idle switch operation.
- Check idle speed and CO content.
- Adjust, if necessary.

## Idle And Full Throttle Switches — Checking/Adjusting

### Idle Switch — Checking

- Check that the throttle stop screw is adjusted properly (see page 18).
- Disconnect the throttle switch connector.
- Connect US 1119 between terminals of the throttle switch plug (1) using self-made jumper harness (see Special Tools list). Set meter to 200 ohm scale.
  - When the throttle valve is closed (idle), multimeter must read 0.0 ohms (continuity through switch).

If **not OK**, the switch must be replaced or adjusted so it is closed at idle.

- Open the throttle valve far enough to open the throttle valve switch.
  - Multimeter must read ( $\infty$ ) ohms (OL on US 1119).

#### Note:

If the throttle switches are misadjusted, the engine may surge at idle or cut out during steady driving on light throttle application.

- Insert a 0.20 mm (0.008 in.) feeler gauge

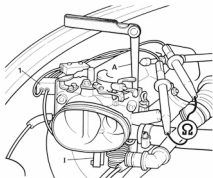

between the stop screw and stop (A) and let the throttle valve close completely.

- The throttle valve switch must **close** (multimeter reads 0.0 ohms).
- Open the throttle valve and insert a 0.60 mm (0.024 in.) feeler gauge. Let the throttle valve close completely.
  - The throttle valve switch must **remain open**. Multimeter reads  $\infty$  ohms (OL on US 1119).

### Idle Switch — Adjusting

- Remove throttle housing from intake manifold.
- Loosen the idle switch and move until the specification is obtained.
- Re-tighten screw.
- Re-check the switch closing point with feeler gauges and US 1119.
- Re-install the throttle housing using a new gasket.
  - Torque: 20 Nm (15 ft.-lbs.)

# Checking/Adjusting

## Idle and Full Throttle Switches — Checking/Adjusting (Cont'd.)

### Full Throttle Switch, Checking:

- US 1119 set 200 ohm scale connected between terminals of the throttle switch using self-made jumper harness (see Special Tools list).
- Screw protractor 3084 to top of the throttle shaft (remove fastening nut for throttle lever, if necessary).

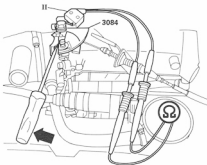

#### Note:

If the throttle switches are misadjusted, the engine may surge at idle or cut out during steady driving or light throttle application.

- Attach pointer for protractor 3084 at throttle cable mounting bracket.
- Using a screwdriver, open throttle lever completely to the full throttle stop and set protractor 3084 to zero.
- Close throttle approximately 20°.
- Multimeter reads ∞ (OL on US 1119), then push slowly in direction of full throttle stop (arrow) until full throttle switch closes and multimeter returns to 0 ohms.
- Full throttle switch must **close** at  $10^\circ \pm 2^\circ$  before full throttle stop.

### Adjusting:

- Loosen the full throttle switch and move until specification is obtained.
- Re-tighten the switch screw.
- Re-check the closing point of switch with protractor 3084.

### Using The Accelerator Pedal:

- Press the accelerator pedal fully to floor.
- Check that the throttle valve is fully open.

If the throttle valve does not open fully,

- Adjust the accelerator cable.

## Idle And Full Throttle Switches — Checking Voltage Supply

- Disconnect throttle switch connector.
- Connect US 1119 across terminals of connector (2) and set to DC voltage.
- Switch the ignition ON.
  - Approximately 5.0 Volts

If the voltage is **not OK**,

- Switch the ignition OFF.
- Re-connect the throttle switch connector.
- Disconnect multi-pin connector from Digifant E.C.U. (Check terminals 6 and 11 for damage.)
- Check for continuity between terminals 6 and 11 of the Digifant E.C.U. (Set US 1119 to 200 ohm scale.)

If there is continuity,

- Replace the E.C.U. and repeat the voltage test.

If there is **no** continuity,

- Disconnect the throttle switch connector.
- Bridge female terminals of throttle switch connector (2) using bridge — end of tool VW 1490.
- Re-check for continuity across terminals 6 and 11 of E.C.U. connector.

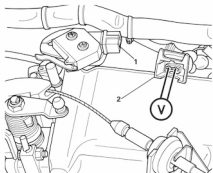

If there is continuity,

- Perform the throttle switch checking/adjusting procedure.

If there is still **no** continuity,

- Repair break in wiring between the Digifant E.C.U. connector and throttle switch connector.

# Checking/Adjusting

## Coolant Temperature Sensor — Checking

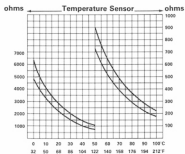

The following checks verify proper function of the coolant temperature sensor, related wiring and connectors.

- Switch the ignition OFF.
- Disconnect the multi-pin connector from the Digifant E.C.U.
- Measure temperature of the coolant temperature sensor with a probe type thermometer.
- Connect US 1119 set to ohm scale across terminals 6 and 10 of the Digifant E.C.U. connector.
  - Resistance should correspond with the graph.

If the resistance is **not** within the specifications,

- Disconnect coolant temperature sensor.
- Measure resistance across the terminals of the coolant temperature sensor with US 1119 set to ohms scale.
  - Resistance should correspond with the graph.

If the resistance is **not OK**,

- Replace the coolant temperature sensor.

If the resistance value is **OK**,

- Repair the wiring to the Digifant E.C.U. using the wiring diagram.

## Air Flow Sensor/Intake Air Temperature Sensor — Checking

### Wiring And Component Checking

The following tests are to verify proper function of the air flow sensor, related wiring and connectors.

- Switch ignition OFF.
- Disconnect multi-pin connector from Digifant E.C.U.
- Connect US 1119 multimeter to terminals of Digifant E.C.U. connector listed in Column "A." Set meter to measure resistance.
  - Readings must correspond to chart.

If readings do **not** meet specifications:

- Disconnect connector at air flow sensor.
- Connect multimeter to terminals of air flow sensor listed in column "B."
- Readings must correspond to chart.

If readings meet specifications.

- Check wiring to Digifant E.C.U.

If readings do **not** meet specifications,

- Replace air flow sensor and re-test.

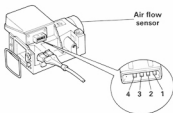
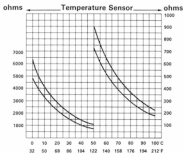
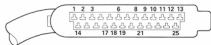

Column "A" Connections at E.C.U. Multi-pin Connector	Column "B" Connections at Air Flow Sensor	Description	Specification
Terminal Nos. 6 and 17	Terminal Nos. 3 and 4	Potentiometer - Total Resistance	500 to 1000 Ohms
Terminal Nos. 17 and 21	Terminal Nos. 2 and 3	Potentiometer - Resistance Measured Through Wiper Arm	Ohms Fluctuate As Sensor Flap Is Opened (Flap Must Move Freely)
Terminal Nos. 6 and 9	Terminal Nos. 1 and 4	Intake Air Temperature Sensor	Ohmmeter Reading Corresponds to Graph



# Checking/Adjusting

## Fuel Injectors — Electrical Checks Voltage Supply

### Requirements

- Hall sender **OK** (ignition coil produces spark while cranking starter).
- Voltage supply from terminal 87 of fuel pump relay is **OK**. (Golf)

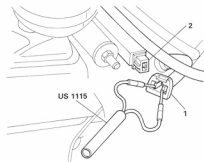

- Voltage supply from terminal 87 of power supply relay is **OK**. (Jetta)
  - Disconnect harness connector (1) from injector wiring harness (2).
  - Bridge terminals of harness connector (1) with LED Tester US 1115.
  - Crank starter.
    - LED Tester must flicker.

If LED Tester does **not** flicker,

- Connect multimeter US 1119 to terminal 2 of the injection harness connector (1) and to ground.
- Switch the ignition ON.
  - Specification: Battery voltage.

If the voltage is **not OK**,

- Repair wiring to terminal 87 of the fuel pump relay (Golf) or power supply relay (Jetta) using the appropriate wiring diagram.

If the voltage was **OK**,

- Disconnect the multi-pin connector from the Digifant E.C.U.
- Check continuity of the wire from terminal 1 of the fuel injection wiring harness connector (1) to terminal 12 of the Digifant E.C.U. connector.

If the continuity was **OK**,

- Replace the Digifant E.C.U.

## Fuel Injectors — Electrical Checks (Cont'd.)

### Injector Resistance

- Disconnect harness connector (1) from fuel injection wiring (2).
- Set US 1119 to 200 ohm scale and measure resistance across connector terminals (2).
  - 3.7 to 5.0 ohms

If total resistance is **not** within specifications, the following readings indicate one or more injectors are not functioning properly:

- 5.0 to 6.7 ohms - 3 injectors **OK**
- 7.5 to 10.0 ohms - 2 injectors **OK**
- 14.0 to 18.0 ohms - 1 injector **OK**

#### Note:

Individual injectors can only be checked when the fuel rail is removed.

To check individual injectors:

- Remove fuel rail (see page 26).
- Measure resistance across terminals of each injector.
  - 14.0 to 18.0 ohms

If resistance is **not** within specification,

- Replace injector(s) and re-check total resistance.

If **all** injectors check **OK**, but total resistance is **high**,

- Replace fuel injector wiring harness (2).

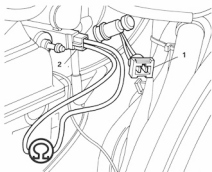

# Checking/Adjusting

## Fuel Injectors — Checking Leak Testing, Delivery Quantity, and Spray Pattern

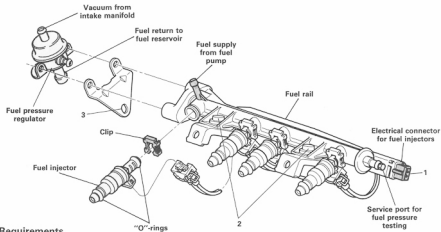

### Requirements

- Resistance values of fuel injectors are within specifications.
- Remove crankcase ventilation valve with hose to the throttle body.
- Remove the intake air boot with the air supply hose to the idle stabilizer.
- Remove the idle stabilizer with the hose to the intake manifold and the stabilizer mounting bracket.
- Disconnect the vacuum hoses from the front of the throttle body.
- Separate the throttle body from the intake manifold and swing aside.
  - Use new gasket when re-installing
  - Torque bolts to 20 Nm (15 ft.-lbs.)
- Disconnect harness plug from the fuel injector wiring harness (1).
- Remove the two 5 mm Allen head bolts mounting the fuel rail assembly to the wiring harness (2).
- Remove the 6 mm Allen head bolt from the fuel pressure regulator bracket (3).
- Pop all four fuel injectors out of the cylinder head simultaneously.
  - Use new O-rings lubricated with engine oil when re-assembling.
  - **Do not** use silicone lubricant on fuel injection hoses or components.
- Disconnect the wiring harness plugs from the fuel injectors.

## Fuel Injectors — Checking Leak Testing, Delivery Quantity, and Spray Pattern (Cont'd.)

### Leak Testing

- Remove the air cleaner assembly.
- Place VW 1348/2B measuring beakers onto the air filter mounting flange.
- Swing fuel injector assembly around and place on VW 1348/2B so that each injector sits in a measuring beaker.
- Remove the fuel pump relay and install remote control switch US 4480/3 in its place.
- Switch remote control US 4480/3 ON.
  - Fuel pumps run.
  - Fuel system is pressurized.
- Observe injector tips for 1 minute.
  - No more than 2 drops may leak from each injector in one minute.

### Checking Delivery Quantity/Spray Pattern

#### WARNING

Fire hazard. Do not smoke or have anything in the area that can ignite fuel when working on the fuel system.

- US 4480/3 connected.
- Connect a spare injector wiring harness (P/N 037 133 339) to the fuel injectors and connect your self-made jumper harness (see Special Tools list).
- Connect remaining lead of jumper harness to negative battery post for exactly 15 seconds while observing injector spray pattern.
  - Spray pattern must be even and cone-shaped.
  - Delivery quantity for each injector must be a minimum of 50 cc after 15 seconds.
  - Difference between high and low delivery quantities must not exceed 5 cc.

#### Note:

If a spare wiring loom is not available,

- Connect your self-made jumper harness to one injector at a time and test each injector individually.
- Connect one lead of the jumper harness to the positive battery post.
- Switch US 4480/3 remote control switch ON.
- If any of the specifications are **not** met,
  - Check the fuel pump pressure and delivery rate if the delivery quantity is low for all injectors.
  - Clean fuel injection system using Volkswagen solvent G 001 600.00 with adapter kit USG16.

# Checking/Adjusting

## Deceleration Fuel Cut-off — Checking

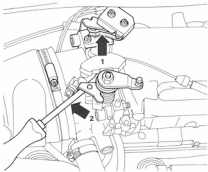
**Note:**

It is possible to check the deceleration fuel cut-off function using the full throttle switch because the full throttle and idle switch are wired in parallel and connected to the Digifant E.C.U. by the same wires.

**Requirements**

- Engine oil temperature at least 80°C (176°F).
- Coolant temperature sensor and wiring **OK**.
- Throttle switches and wiring **OK**.
- VW engine tester 1367 connected.
- Start the engine and raise speed to a minimum of 2100 RPM four times, letting the throttle close each time,
- With engine idling, close throttle switch with thumb (1).
- While holding full throttle switch closed, SLOWLY open the throttle with a screwdriver (2) to increase engine speed.
  - At approx. 2200 - 2700 RPM, the injection will be cut off and RPM will drop.
  - At approx. 1300 - 1800 RPM, the injection will re-activate and RPM will rise.
  - This cycle will continue as long as you try to hold the RPM steady at 2700 RPM.

If the cycle does **not** occur,

- Replace the Digifant E.C.U.

## Full Throttle Enrichment — Checking

### Requirements

- Engine oil temperature at least 80° C (176° F).
  - Coolant temperature sensor and wiring **OK**.
  - Throttle switches and wiring **OK**.
  - VW 1367 engine tester and EPA 105 CO tester connected.
- Start the engine and raise speed to a minimum of 2100 RPM four times, letting the throttle close each time.
- Open the throttle slowly with a screwdriver (2) to increase engine speed to 5100 RPM and note CO reading (allow a moment to let CO reading stabilize).
- While maintaining 5100 RPM, push and hold full throttle switch closed with your thumb.
- After 2 or 3 seconds, CO content must increase by at least 1.5% from initial reading.

If the CO reading does **not** increase,

- Replace the Digifant E.C.U.

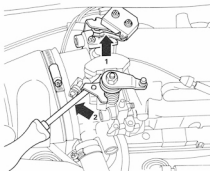

# Checking/Adjusting

## Oxygen Sensor System — Checking

### Requirements

- Engine oil temperature must be at least 80°C (176°F) and radiator cooling fan must come on at least once.
- Idle speed, timing, and CO content **OK**.
- The exhaust system between catalytic converter and cylinder head is not leaking.

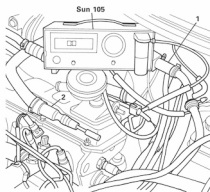

- The voltage supply for oxygen sensor heater is **OK**.
  - The coolant temperature sensor and oxygen sensor connected.
  - All electrical consumers switched OFF and radiator cooling fan must **not** be running during checking or adjusting.
- Remove the cap from the CO tap tube.
  - Connect EPA 105 CO tester (or EPA approved equivalent) to CO tap tube using only special tool 6006-0019 or equivalent (non-approved hoses may dramatically alter the readings).
  - Start the engine and raise speed to a minimum of 2100 RPM four times, letting the throttle close each time.
    - This clears the fault memory in the E.C.U. and cancels the hot-start idle increase function.
  - Check CO and record reading.
  - Remove the oil fill cap from valve cover and observe CO reading.
    - CO content must drop briefly and then increase to original value.

### Note:

If the CO content does not drop, there is a vacuum leak in the system.

## Oxygen Sensor System — Checking (Cont'd.)

If CO content **does** return to original value:

- Oxygen sensor system is **OK** and compensating properly.
- Re-install oil filler cap.

If CO content does **not** return to original value:

- Switch engine OFF and re-install oil filler cap.
- Disconnect oxygen sensor at 3-way connector.

**Note:**

Some early vehicles are not equipped with a 3 pin lambda connector. On these vehicles, disconnect only the oxygen sensor connection (Arrow).

- Start the engine and raise speed to a minimum of 2100 RPM four times, letting the throttle close each time.
- Connect jumper wire lead to the terminal for the green wire which goes to the Digifant E.C.U. (Arrow).

**Note:**

On 3 pin connector, connect jumper to terminal 1 in the white hardshell (black wire).

- Hold jumper wire briefly to ground.
  - CO content must rise.

If CO content rises:

- Replace the oxygen sensor.

If CO content does **not** rise:

- Check for broken or grounded wire between oxygen sensor connector and terminal 2 of the E.C.U. connector.

If the wiring is **OK**:

- Replace the Digifant E.C.U.

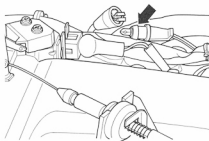



# Checking/Adjusting

## Fuel Pumps — Checking

(One or both pumps do not run with engine running or while cranking)

### Requirements

- Fuel pump fuse removed.
- Ignition coil produces spark while cranking starter.

- Disconnect the multi-pin connector from the Digifant E.C.U.
- Bridge terminals 3 and 13 of the connector using jumper wire (with proper terminal ends).
- Switch the ignition ON.
  - Both fuel pumps must run.

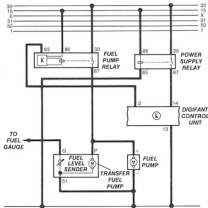

### If both fuel pumps run:

- All the fuel pump wiring circuits are operating properly except the ground circuit from the Digifant E.C.U. to the fuel pump relay.
- Switch the ignition OFF and remove the jumper wire from the Digifant E.C.U.
- Check the continuity of the wire from terminal 3 of the E.C.U. connector to terminal 85 of the fuel pump relay with an ohmmeter.

#### Note:

Check that the terminal ends of the Digifant E.C.U. connector are not damaged.

If there is **no** continuity:

- Repair the wiring using wiring diagram.

If there is continuity:

- Replace the Digifant E.C.U.

## Fuel Pumps — Checking (Cont'd.)

(One or both pumps do not run with engine running or while cranking)

### If only one fuel pump runs:

- Ignition ON, jumper wire installed between terminals 3 and 13.
- Check for battery voltage at the plus (+) side of the inoperative pump with voltmeter.

### If voltage is **not** present:

- Repair the wiring to the fuel pump from terminal 87 of the fuel pump relay.
- Check the continuity of the wire from the negative (-) side of the fuel pump to ground with an ohmmeter.

### If there is **no** continuity:

- Repair the wiring from the fuel pump to ground using the wiring diagram.
- If both the power supply and the ground circuits are **OK**,
- Replace inoperative fuel pump.

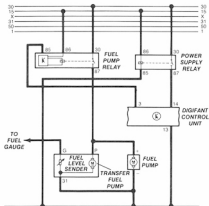

# Checking/Adjusting

## Fuel Pump — Checking (Cont'd.)

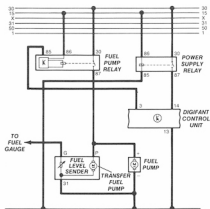

### If neither fuel pump runs:

- Ignition ON, jumper wire installed between terminals 3 and 13.

— Check for battery voltage to terminals 86 and 30 of the fuel pump relay with a voltmeter.

If there is **no** voltage present:

- Repair power supply to the fuel pump relay using wiring diagram.
- Check for battery voltage at terminal 87 of the fuel pump relay (with relay installed).

If there is **no** voltage present:

- Replace the fuel pump relay.
- Check for battery voltage at the positive (+) terminal of each fuel pump.

If there is **no** voltage present:

- Repair wiring from the fuel pumps to terminal 87 of the fuel pump relay using wiring diagram.
- Switch the ignition OFF.
- Check continuity in the wiring from the negative (-) terminal of each fuel pump to ground.

If there is **no** continuity:

- Repair wiring for the fuel pump ground circuits using the wiring diagram.

If the continuity is **OK**,

- Replace the inoperative fuel pumps.

## Fuel Pump — Checking (Cont'd.) Current Draw — Checking

### Requirements

- Battery fully charged.
- Voltage supply **OK**.
- Remove fuel pump relay.
- Plug US 4480/3 into relay socket.
- Remove fuel pump fuse.
- Connect US 1119 across fuse terminals and set to 10 A scale.

- Switch US 4480/3 ON to run fuel pumps.
  - Amperage of combined pumps is approx. 4.2 A
- Plug and unplug individual fuel pump to obtain desired readings.
  - Transfer pump: approx. 1.2 A
  - Main pump: approx. 3.0 A

A lower reading may indicate a poor ground circuit.

A higher reading may indicate a dragging fuel pump motor that must be replaced.

## Delivery Rate — Checking

### Transfer pump requirements

- Battery fully charged.
- Voltage supply **OK**.
- Current draw **OK**.
- Fuel filler cap removed.
- Remove fuel pump relay.
- Set US 4480/3 to OFF position and install in relay socket.
- Remove black feed hose (1) from fuel sending unit and plug the hose end.
- Install auxiliary hose (2) onto open connection of sending unit and place the other end in a measuring beaker.

- Switch US 4480/3 ON for 10 seconds.
  - There should be a minimum of 300 cc of fuel in ten seconds.

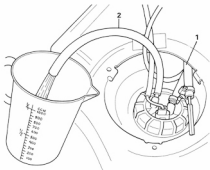

# Checking/Adjusting

## Fuel Pump — Checking (Cont'd.) Delivery Rate — Checking (Cont'd.)



### Main fuel pump requirements

- Battery fully charged.
  - Voltage supply **OK**.
  - Current draw **OK**.
  - Fuel filler cap removed.
  - Transfer pump **OK**.
  - Fuel filter **OK**.
- Disconnect the blue fuel return hose (from the pressure regulator) where it attaches to the main return line near the right shock tower.
  - Place the hose end into a measuring beaker.
  - Switch US 4480/3 ON for about 30 seconds.
    - There should be a minimum of 500 cc fuel in 30 seconds.

## Fuel Pressure/Residual Pressure — Checking

**Note:**

The fuel pressure is regulated by the fuel pressure regulator, depending on the intake manifold vacuum.

**Requirements**

- **No** visible fuel leaks from any lines, components, or connections.

**Fuel Pressure Checking**

- Remove the screw plug from the end of fuel rail (A).
- Connect pressure gauge VW 1318 to fuel rail using adapter VW 1318/17.
- Valve on the pressure gauge (B) must be in CLOSED position (lever must be at a right angle to direction of flow).
- Run engine at idle speed and observe fuel pressure.
  - 2.5 Bar (36 psi) with vacuum hose to pressure regulator connected.
  - 3.0 Bar (44 psi) with vacuum hose to pressure regulator disconnected.

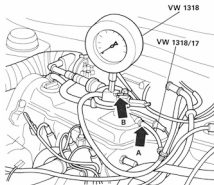
**WARNING**

Fire hazard. Do not smoke or have anything in the area that can ignite fuel when working on the fuel system.

Remove fuel filler cap to relieve fuel pressure before connecting fuel pressure gauge. Protect your eyes and hot engine parts from fuel spray when attaching the fuel pressure gauge.

**If the fuel pressure is too high:**

- Check the fuel return line to the fuel reservoir for kinks and obstructions.

If the return line to the reservoir is **OK**,

- Replace the fuel regulator.

# Checking/Adjusting

## Fuel Pressure/Residual Pressure — Checking (Cont'd.)

### If the fuel pressure is too low:

- Clamp the blue fuel return hose from the pressure regulator shut for a few seconds and observe the pressure gauge.
  - Fuel pressure must increase to a minimum of 3 Bar (44 psi).

### If the fuel pressure increases:

- Replace the fuel pressure regulator.

### If the fuel pressure does **not** increase:

- Check the transfer pump delivery rate.

### If the delivery rate is **OK**:

- Check the main fuel pump delivery rate.

### If the delivery rate is **OK**:

- The fuel filter is clogged or the feed line to the fuel rail is restricted.

## Residual Pressure Checking

- Run the engine to build up fuel pressure.
- Shut the engine OFF and observe pressure gauge VW 1318.
  - After ten minutes, the fuel pressure must be at least 2 Bar (29 psi).

### If the fuel pressure drops below specification:

- Start the engine to build up fuel pressure.
- Shut the engine OFF and immediately clamp blue fuel return hose from fuel pressure regulator shut.

### If the pressure drop stops or slows dramatically:

- Replace the fuel pressure regulator.

- Start the engine to build up fuel pressure.
- Stop the engine and clamp the black fuel feed line to the fuel rail shut.

### If the fuel pressure drop stops or slows dramatically:

- Replace the main fuel pump.
- Start the engine to build up fuel pressure.
- Stop the engine and observe pressure gauge VW 1318.

### If the fuel pressure continues to drop:

- Check the fuel injectors for leaks.

## Ignition System — Checking

(No spark from ignition coil while cranking)

- Connect US 1119 to measure voltage at terminal 15 of the ignition coil.
- Switch ignition ON.
  - Specification: Battery voltage.

If voltage is **not OK**:

- Repair fault in wiring.

If voltage is **OK**:

- Connect US 1115 L.E.D. Tester to terminal 1 of the ignition coil and crank engine.
  - Tester must flash while cranking.

If Tester flashes:

- Replace the ignition coil.

If the Tester does **not** flash:

- Check Hall system as follows:

### Part A

- Remove the wiring connector from the distributor.
- Switch the ignition ON.
- Measure voltage at outer terminals of wiring connector.
  - Reading should be a minimum of 5 Volts.

If the voltage is **OK**:

- Go to part **B**, next page.

If the voltage is **not OK**:

- Remove wiring connector from the Digifant E.C.U. and connect a voltmeter across terminals 13 and 14.
- Switch the ignition ON.
  - Specification: Battery voltage.

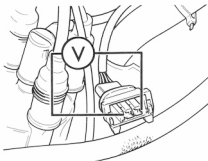



# Checking/Adjusting

## Ignition System Checking (Cont'd.)

If voltage is **not** present across Digifant E.C.U. connector terminals 13 and 14,

- Repair the wiring using wiring diagram.

If voltage is present across E.C.U. terminals 13 and 14,

- Check the wire from terminal 6 of the Digifant E.C.U. to terminal 1 at the distributor connector (BR/W wire).

If there is **no** continuity,

- Repair wiring using wiring diagram.

If there is continuity,

- Check wire from terminal 8 of the Digifant E.C.U. to terminal 3 at the distributor connector (R/BK wire).

If there is **no** continuity,

- Repair wiring using wiring diagram.

If there is continuity,

- Replace the Digifant E.C.U. and re-test.

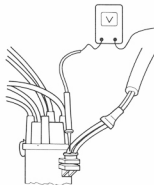

- Reconnect wiring to the distributor and peel back rubber boot.
- Connect US 1119 between the center terminal of the connector and the positive side of the battery.

## Part B

- Set meter to 20 V scale.
- Crank engine.
  - Voltmeter reading must fluctuate.

If voltmeter reading does **not** fluctuate,

- Replace Hall sender and re-test.

If voltmeter reading **does** fluctuate,

- Check for continuity in wire from terminal 18 of the Digifant E.C.U. to the center terminal at the distributor (G/W wire).

If the wire is **not OK**,

- Trace and repair fault in wiring.

If the wire is **OK**,

- Replace the Digifant E.C.U. and re-test.

## Knock Sensor — Checking

### Requirements

- Engine oil temperature must be a minimum of 80° C (176° F) and radiator cooling fan must come on at least once.
- Ignition timing must be within specifications.
  - Connect VW 1367 (ignition switched OFF).
  - Start the engine and raise speed to a minimum of 2100 RPM four times, letting the throttle close each time.

### Note:

This clears the fault memory in the E.C.U. and cancels the hot-start idle increase function. This must be repeated each time the vehicle is stopped and re-started during the test procedure.

- Disconnect the coolant temperature sensor.
- Increase the engine speed to 2300 ± 50 RPM and record ignition timing.
- Reconnect the coolant temperature sensor.
- Briefly raise engine speed above 3000 RPM to store the knock sensor information in the E.C.U.
- Increase engine speed to 2300 ± 50 RPM and re-check ignition timing.
  - Ignition timing must advance by 30° ± 3° from initial setting.

If timing does **not** advance by 30° ± 3° from initial setting:

- Check knock sensor torque and wiring to Digifant E.C.U. using the wiring diagram.
  - Torque: 15 Nm - 25 Nm (11-18 ft-lbs.)

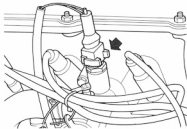
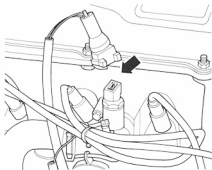

If knock sensor torque and wiring are **OK**:

- Check the engine coolant temperature sensor and wiring to the Digifant E.C.U.

If the coolant temperature sensor and wiring are **OK**:

- Replace the knock sensor.  
**or**  
— Replace the Digifant E.C.U.

# Checking/Adjusting

## Idle Stabilization — Checking

### Requirements

- Engine oil temperature is at least 80° C (176° F).
- Basic engine settings checked and idle speed **not** within specifications.
- Coolant temperature sensor and wiring **OK**.
- Idle switch and wiring **OK**.
- All electrical consumers switched OFF (coolant fan must not run during checking or adjusting).
- Connect VW 1367 engine tester.
- Connect digital multimeter to idle stabilizer using adapter VW 1315A/2. Set meter to 5 or 10 amp. scale (reading will be in milliamps).
- Start engine and raise speed to a minimum of 2100 RPM four times, letting the throttle close each time.

#### Note:

This must be repeated each time the engine is stopped and re-started.

- Disconnect the coolant temperature sensor and observe stabilizer control current.
  - Specification: Approximately 430 mA and fixed (non-fluctuating).

If control current is **not OK**,

- Check continuity of the wiring from the idle stabilizer to terminals 22 and 23 of the Digifant E.C.U.

If the continuity is **OK**,

- Replace the Digifant E.C.U. and re-test.
- Observe the idle RPM.
  - Must be  $975 \pm 50$  RPM.

If **not OK**,

- Adjust by turning the idle-air bypass screw on the throttle body.
- Reconnect the coolant temperature sensor and observe the readings.
  - Idle speed must drop to  $800 \pm 50$  RPM.
  - Stabilizer control current must drop to  $400 \pm 20$  mA.

If **not OK**,

Idle RPM is **OK**, but control current is **high**:

- Probable engine vacuum leak.
- Locate and repair.

Idle RPM is **OK** but control current is **low**, or idle RPM is **high** and control current is **OK** or **low**:

- Stabilizer valve is sticking open.
- Clean or replace stabilizer valve. (Check adjustment if valve has been modified.)

Idle RPM is **low**, and control current is **high**:

- Stabilizer valve is sticking shut.
- Modify stabilizer valve as per Group 24 of Technical Information.

## Idle Stabilization — Checking (Cont'd.)

### Milliamp Increase While Cranking Starter

#### Requirements

- Idle stabilizer valve **OK** (the valve must vibrate and hum with the engine running).
- Connect digital multimeter to idle stabilizer using adapter VW 1315A/2. Set meter to 5 or 10 amp. scale (reading will be in milliamps).
- Ground ignition coil terminal #4.
- Crank engine.
  - Stabilizer current should increase beyond 430 mA while cranking starter.

#### If not OK,

- Disconnect multi-pin connector from the Digifant E.C.U.
- Check continuity of wire from terminal 1 of E.C.U. connector to terminal 50 of starter motor.

#### If the continuity is **OK**,

- Replace the Digifant E.C.U. and retest.

### Milliamp Increase for A/C Operation

#### Requirements

- Idle stabilizer valve **OK** (the valve must vibrate and hum with the engine running).
- Connect digital multimeter to idle stabilizer using adapter VW 1315A/2. Set meter to 5 or 10 amp. scale (reading will be in milliamps).
- Start engine and raise speed to a minimum of 2100 RPM four times, letting the throttle close each time.
- With engine idling, observe milliamp reading at the idle stabilizer.
- Switch the A/C ON.
  - Milliamp reading must increase by approximately 150 mA when the A/C compressor is engaged.

#### If there is **no** milliamp increase,

- Stop the engine.
- Disconnect the multi-pin connector from the Digifant E.C.U.
- With the ignition and A/C switched ON, check for 12 volts at terminal 16 of the Digifant E.C.U. connector.

#### If there is **not** 12 volts at terminal 16 of the Digifant E.C.U. connector,

- Repair the wiring between terminal 16 of the Digifant E.C.U. connector and the A/C thermostat on the evaporator. (See the wiring diagram)

#### If there is 12 volts at terminal 16 of the Digifant E.C.U. connector,

- Replace the Digifant E.C.U. and re-test.

# Checking/Adjusting

## Evaporative Emission System — Checking

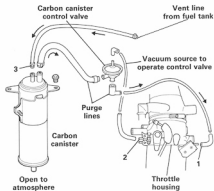

### Control Valve — Checking

#### Requirements

- Engine oil temperature is at least 80°C (176°F) and radiator cooling fan has operated at least once.
- Idle speed is within specification.
- Start engine and raise speed to a minimum of 2100 RPM four times, letting the throttle close each time.
- Remove the white nylon purge line from the rear of the throttle body (1) and connect vacuum pump US 8026 or equivalent to open end of line.
- Apply 5 to 10 in. Hg. vacuum and observe.
  - Carbon canister control valve must retain vacuum.

If the control valve does **not** retain vacuum:

- Remove vacuum line from purge control fitting on front of the throttle body (2), and attach vacuum pump US 8026 or equivalent.
  - At idle, there must be less than 1 in. Hg. of vacuum.

If there is more than 1 in. Hg. of vacuum:

- Do basic throttle valve adjustment before proceeding.

If there is 1 in. Hg. of vacuum or less:

- Replace the carbon canister control valve.

# Checking/Adjusting

## Evaporative Emission System — Checking (Cont'd.)

- Reconnect vacuum line to purge control fitting (2).
- Reconnect vacuum pump US 8026 or equivalent to purge line (1).
- Start the engine and raise speed to a minimum of 2100 RPM four times, letting the throttle close each time.
- Apply 5 to 10 in. Hg. vacuum and observe.
  - Control valve must maintain vacuum at idle.
- Accelerate engine by hand.
  - Control valve must release vacuum.

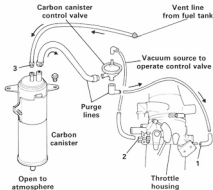

If the control valve does **not** release vacuum:

- Either the vacuum fitting on the throttle body (2) is plugged, or the control valve is stuck in the closed position.

### Checking System For Leaks

- Switch ignition OFF.
- Remove fuel tank vent line from top of carbon canister (3), and attach leak tester US 4487 to the open end of the line.
- Pressurize the system to 3.3 cm-Hg. (1.3 in.) and observe.
  - The system is **OK** if the pressure is 2.54 cm (1.0 in.) or greater after 5 minutes.
  - The system is leaking if the pressure drops below 2.54 cm (1.0 in.) in 5 minutes.

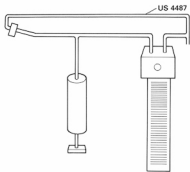

- Locate leaks by applying a soap solution to all connections and fittings while the system is pressurized.
- Seal leaks as necessary.

# Checking/Adjusting

## Intake Air Preheating — Checking

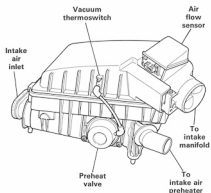

### Vacuum thermostwitch — checking requirements

- Vacuum source to thermostwitch from throttle body **OK**.
- Using a Tee fitting, connect vacuum pump US 8026 or equivalent in vacuum circuit from lower fitting of thermostwitch to preheat valve.
- Loosen upper and lower air filter housing clips and slip a probe type thermometer between the halves to monitor the temperature in the air filter housing.
- Start the engine and raise speed to a minimum of 2100 RPM four times, letting the throttle close each time.
- With engine idling, observe temperature in air filter housing and vacuum reading on vacuum pump.
  - If the temperature in filter housing is approximately 27° C (80° F) or **higher**, vacuum reading should be 0 in. Hg. (thermostwitch closed).
  - If the temperature in the filter housing is approximately 24° C (75° F) or **less**, vacuum reading must be more than 0 in. Hg. (thermostwitch open).

If the readings are **not** within specifications:

- Replace vacuum thermostwitch.

#### **Note:**

You can simulate these conditions by alternately using a heat gun and compressed air.

## Intake Air Preheating — Checking (Cont'd.)

### Preheat valve

- Disconnect vacuum line from preheat valve (Arrow).
- Remove air filter.
- Check position of the preheat valve regulator flap in the lower filter housing.
  - Flap must seal against the preheated air inlet (1).

If the flap does **not** seal against the inlet:

- Replace the preheat valve assembly.
- Connect vacuum pump US 8026 or equivalent to open fitting of preheat valve (Arrow).
- Apply vacuum until regulator flap begins to move, then continue applying vacuum while observing flap.
  - Flap must move smoothly with no signs of binding or hesitation until it closes against ambient air inlet (2) and then retain vacuum.

If flap does **not** move in this manner:

- Replace the preheat valve assembly.

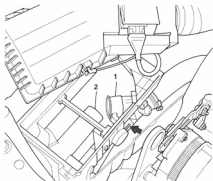



# Checking/Adjusting

## Ignition Timing, CO Content, and Idle Speed Checking/Adjusting

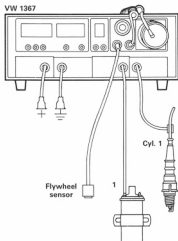

### Note:

Check and adjust the basic engine setting in the following order:

- Ignition timing
- CO content
- Idle speed

### Test and adjustment conditions:

- Engine oil temperature must be at least 80°C (176°F) and radiator cooling fan has operated at least once.
  - All electrical consumers switched OFF (radiator cooling fan must not be running during checking or adjusting).
  - Idle switch functioning properly.
  - Idle stabilization system **OK** (the valve must vibrate and hum while engine is running).
- Switch ignition OFF.
- Connect VW 1367 engine tester.
- Connect SUN 105 CO Tester (or EPA approved equivalent) to CO tap tube using Special Tool 6006-0019 or equivalent (high temperature silicone connecting hose).

### Note:

Non-approved hoses may dramatically alter your readings.

## Ignition Timing, CO Content, and Idle Speed Checking/Adjusting (Cont'd.)

### Ignition timing

- Start the engine and raise speed to a minimum of 2100 RPM four times, letting the throttle close each time.

**Note:**

This clears the fault memory in the E.C.U. and cancels the hot-start idle increase function. This must be repeated each time the vehicle is stopped and re-started during the test procedure.

- Remove connector from coolant temperature sensor (Arrow).
- Increase engine speed to  $2300 \pm 50$  RPM and check ignition timing.
  - Specification:
    - Checking:  $4^{\circ}$  to  $8^{\circ}$  BTDC
    - Adjusting:  $6^{\circ} \pm 1^{\circ}$  BTDC

If adjustment is necessary:

- Loosen distributor and rotate until specification is correct.
- Tighten distributor clamp bolt to 25 Nm (18 ft.-lbs.).

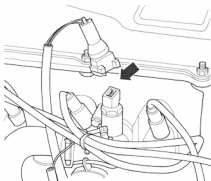

# Checking/Adjusting

## Ignition Timing, CO Content, and Idle Speed Checking/Adjusting (Cont'd.)

Idle CO For 1.8L Digifant II Checking Tolerance

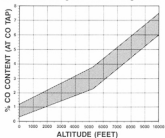

Idle CO For 1.8L Digifant II Adjusting Specification

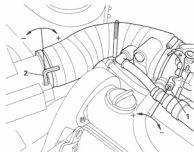
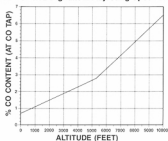

### CO content

#### Note:

Be sure to check the Emissions Label under the hood.

- Disconnect coolant temperature sensor.
- Raise dipstick slightly to allow for crankcase ventilation, then clamp crankcase breather hose near PCV valve shut.
- Adjust idle speed to  $800 \pm 50$  RPM.
- Check CO specification.
  - CO reading must fall within band on Checking Tolerance graph.

If CO reading does **not** fall within tolerance band:

- Remove tamper-proof plug from adjustment location on air flow sensor by drilling into plug with a 2.5 mm (0.098 in.) drill bit.
- Thread a 3 mm (0.137 in.) sheet metal screw into the drilled hole.
- Pull out screw (with plug) using pliers.
- Adjust CO as necessary by using a 5 mm hex wrench to turn adjusting screw in air flow sensor (2).
  - Specification: adjust CO content according to Adjusting Specification graph.

## Ignition Timing, CO Content, and Idle Speed Checking/Adjusting (Cont'd.)

### Idle speed

- Remove clamp from crankcase breather hose and re-seat oil level dipstick.
- Set base idle speed.
  - Specification:  $975 \pm 50$  RPM
- Reconnect coolant temperature sensor.
  - Idle speed must drop to  $800 \pm 50$  RPM
  - CO% must go up to  $0.7\% \pm 0.4\%$  (at any altitude).

### If OK,

- Install a new tamper-proof plug over CO adjustment screw (if removed).
- Disconnect test equipment.

### If only the idle speed is **not OK**:

- Check idle switch and wiring.
- Check idle stabilization system.

### If only the CO% is **not OK**:

- Check the oxygen sensor system.

### If the idle speed **and** CO% are **not OK**:

- Check the coolant temperature sensor and wiring.

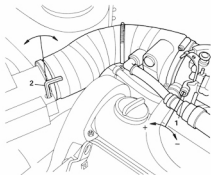

# Checking/Adjusting

## System Check With Volt/Ohmmeter

### Requirements

- Ignition switched OFF.
- Digifant E.C.U. multi-pin connector disconnected.
- High voltage coil wire removed from ignition distributor and grounded.

### CAUTION

To avoid damage to control units, switch multimeter to appropriate range before connecting to components.

OHMMETER TO TERMINAL	COMPONENTS	CHECKS/TEST CONDITIONS	SPECIFICATIONS
2 and 13	Oxygen Sensor	<ul style="list-style-type: none"><li>• Connector Disconnected and Grounded</li><li>• Connector Connected</li></ul>	0 ohms $\infty$ ohms
6 and 9	Temp. Sensor I (Intake Air Temp.)	<ul style="list-style-type: none"><li>• Resistance</li></ul>	Corresponding with graph on next page
6 and 10	Temp. Sensor II (Coolant Temp.)	<ul style="list-style-type: none"><li>• Resistance</li></ul>	
6 and 11	Throttle Switches	<ul style="list-style-type: none"><li>• Idle Position</li><li>• Half Throttle Position</li><li>• Full Throttle Position</li></ul>	0 ohms $\infty$ ohms 0 ohms
6 and 17	Air Flow Sensor	<ul style="list-style-type: none"><li>• Total Resistance</li></ul>	500 to 1000 ohms
17 and 21	Air Flow Sensor	<ul style="list-style-type: none"><li>• Resistance Through the Potentiometer</li></ul>	Ohms fluctuate as sensor plate is opened
*12 and 14 (Jetta Only)	Fuel Injectors	<ul style="list-style-type: none"><li>• Total Resistance</li></ul>	3 to 5 ohms
Check at Components	Individual Fuel Injectors	<ul style="list-style-type: none"><li>• Resistance (Each)</li></ul>	14 to 18 ohms
22 and 23	Idle Stabilization Valve	<ul style="list-style-type: none"><li>• Continuity</li></ul>	0 ohms
4 and 5 4 and 7	Knock Sensor Wiring	<ul style="list-style-type: none"><li>• Separate connector to knock sensor and bridge all 3 wires in connector</li></ul>	0 ohms
6 and 8 6 and 18	Hall Sender Wiring	<ul style="list-style-type: none"><li>• Separate connector to Hall sender and bridge all 3 wires in connector</li></ul>	0 ohms
#25 at ECU and #6 at Hall Control Unit	Wiring to Hall Control Unit	<ul style="list-style-type: none"><li>• Continuity (Connector separated from Hall control unit)</li></ul>	0 ohms
13 and Grd.	Control Unit Ground	<ul style="list-style-type: none"><li>• Continuity</li></ul>	0 ohms
19 and Grd.	Engine Ground	<ul style="list-style-type: none"><li>• Continuity</li></ul>	0 ohms

#### \*Note:

On Golf, check total resistance of fuel injectors at fuel injection wiring harness connector.

# Checking/Adjusting

## System Check With Volt/Ohmmeter (Cont'd.)

VOLTMETER TO TERMINAL	COMPONENTS	CHECKS/TEST CONDITIONS	SPECIFICATIONS
1 and 13	Wiring from Starter	<ul style="list-style-type: none"> <li>• Voltage from Terminal 50 During Cranking (Starting Injection)</li> </ul>	Cranking voltage (Min. 8 volts)
3 and 13 Bridged	Fuel Pump Relay	<ul style="list-style-type: none"> <li>• Ignition ON</li> </ul>	Fuel pumps run
13 and 14	Power Supply Relay	<ul style="list-style-type: none"> <li>• Ignition ON</li> </ul>	Battery voltage

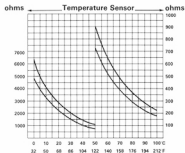

# On Board Diagnosis (California Only)

## On Board Diagnosis System

1988 and 1989 vehicles for California equipped with the Digifant II Engine Management System have a permanent, erasable fault memory in the E.C.U. for self-diagnosis.



This memory constantly monitors the Engine Management System and stores any faults that could cause the vehicle to fail an exhaust emissions inspection.

Such faults can **ONLY** be determined (and stored) by driving the vehicle a minimum of 10 minutes.

An indicator light labeled CHECK is located in a rocker switch on the instrument panel. Each time the engine is started, the indicator light will flash once to inform the operator that the bulb is working.

The light will come on and stay on if a fault develops that could cause the vehicle to fail an exhaust emissions inspection. The light is also used to display a diagnosis code to help the technician repair a problem in the system.

## Diagnostic Codes

A diagnostic code consists of four groups of flashes of the indicator light. Each group has a maximum of four flashes. There is a 2.5 second pause (light OFF) between each group of flashes.

The indicator light will come on for two and a half seconds prior to displaying a fault code when the diagnosis procedure is activated. The fault code will continue repeating while the ignition is on.

To continue to next fault code, depress the rocker switch for at least four seconds.

If the fault is not repaired, the indicator light will come on and stay on when the ignition is switched back **on** to signify that the fault still exists.

The following is an example of the fault code 2342.

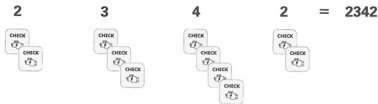

# On Board Diagnosis (California Only)

## Diagnosis Procedure

If a fault is detected and stored in the E.C.U., the fault lamp will light after one minute.

To activate the diagnostic procedure,

- Switch the ignition ON but do not start the engine.
- Press and hold down the rocker switch for longer than four seconds then release.
  - The fault indicator lamp will begin flashing diagnosis code.
- Press and hold down the rocker switch again for longer than four seconds then release.
  - The indicator lamp will flash the next diagnostic code (if any.)

### Note:

Do **not** press the rocker switch during the warning light pauses or the E.C.U. will **not** switch to the next memorized code.

When all the diagnostic codes have been displayed, the indicator lamp will flash its "End of Fault Sequence" code.

This is a series of 2.5 second flashes ON and 2.5 seconds OFF.

### CAUTION:

Check the wiring and components before making any repairs when a fault code is displayed.

This is a sensitive system that may occasionally sense temporary deviations in

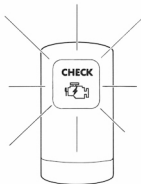

If there are NO faults stored in the E.C.U. memory, the indicator lamp will flash code 4444.

For a complete listing of all possible diagnostic codes, see the table on page 57.

the air/fuel mixture that are inherent in the normal operation of every vehicle. If a fault code is displayed but no apparent malfunction exists with the indicated component or wiring, check Group 24 of your Technical Information Book for additional information.



# On Board Diagnosis (California Only)

## On Board Diagnosis (Cont'd.)

The system has a permanent memory and must be cleared after a fault has been repaired. To cancel the memory, the following sequence must be followed.

- The ignition must be OFF.
  - Depress the rocker switch and hold.
  - Turn the ignition ON and keep the rocker switch depressed for at least four (4) seconds and then release.
  - Switch OFF ignition
- If **no** faults exist, the memory will be cleared.



# On Board Diagnosis (California Only)

## Diagnostic Codes

CODE	LOCATION OF FAULT	PROBLEM
2142	Knock sensor	Sensor or sensor wiring
2232	Air flow sensor	Sensor or sensor wiring
2312	Coolant temperature sensor	Sensor or sensor wiring
2322	Air temperature sensor	Sensor or sensor wiring
2342	Oxygen sensor	Sensor or sensor wiring
4444	No faults have been recorded	
0000	End of diagnosis	

The code 0000 is displayed by the indicator light coming on for 2.5 seconds and going off for 2.5 seconds repeatedly.

# Wiring Diagram

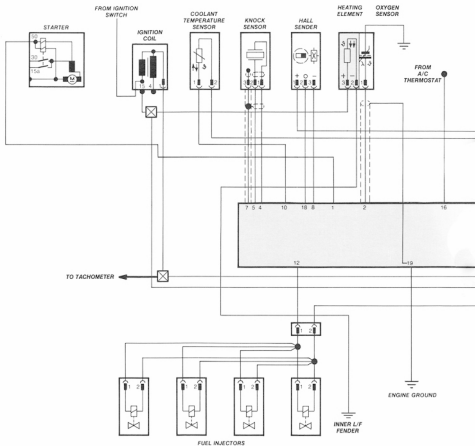

## Golf

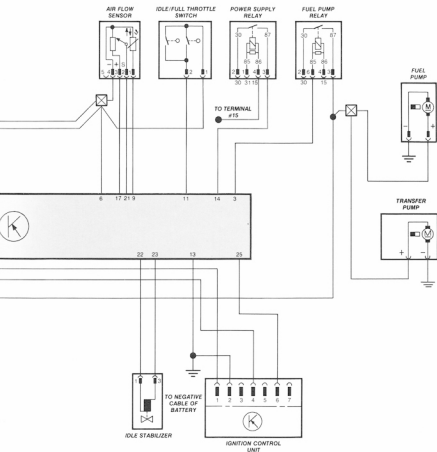

# Wiring Diagram

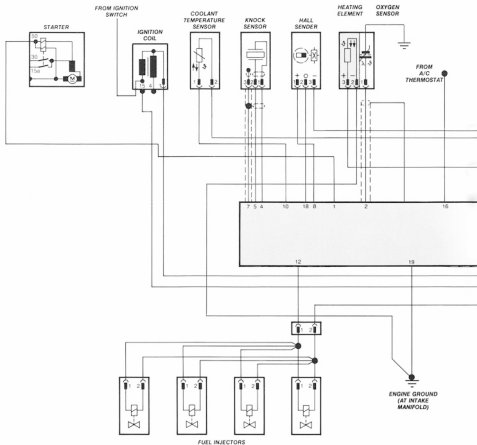

# Wiring Diagram

## Jetta

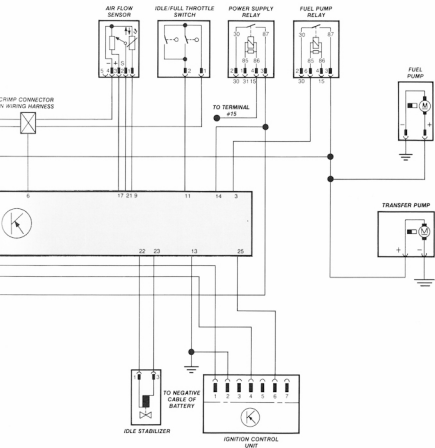

# Special Tools

## Minimum Requirement

- US 1115 LED (Light-Emitting Diode) Test Probe
- VW 1367 Engine Tester
- US 1119 Digital Multimeter
- US 1076 or VW 1318 (with Adapter VW 1318/17) Pressure Gauge
- SUN 105 Exhaust Gas Analyzer
- 6006-0019 Adapter Hose — Connecting SUN 105 to CO Tap Tube
- VW 1315A/2 Adapter Harness — Checking Idle Stabilizer Valve
- US 8026 Hand Operated Vacuum Pump
- VW 1490 Resistance Block
- US 4480/3 Remote Control Switch for Fuel Pumps
- VW 1348/2B Measuring Beaker Set (Component of VW 1348)
- US 4487 Evaporative Emissions System Leak Tester

## Obtain/Make Locally

- 1 Liter Graduated Glass Measuring Beaker

Jumper Harness for Checking Injection Quantity, Injector Spray Pattern, and Individual Injector Resistance

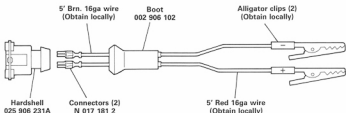

## **AIR FLAP POTENTIOMETER**

A variable resistor connected to the air flow sensor that provides a signal for determining fuel system enrichment. Location: internal component of air flow sensor (not available separately).

## **AIR FLOW SENSOR**

Measures the amount of air entering the intake manifold and sends a voltage signal to the electronic control unit. Location: attached to air filter housing.

## **BAR**

Unit of measurement pressure — 1 bar is approx. 14.5 PSI.

## **COOLANT TEMPERATURE SENSOR**

A sensor for measuring engine coolant temperature to determine cold running engine operation. Location: Front side of cylinder head between No. 3 and 4 cylinder.

## **ELECTRONIC CONTROL UNIT (E.C.U.)**

Provides the proper actuation signal to the injectors and optimum ignition timing point based on inputs from other system components. Location: inside engine compartment, left side in plenum.

## **FUEL FILTER**

A filter which removes foreign particles from the fuel system. Location: Attached to fuel reservoir in front of the fuel tank on the right side.

## **FUEL PUMP**

An electric pump which delivers fuel to the injectors. Location: Inside the fuel reservoir.

## **FUEL SCREEN**

A strainer which removes foreign particles from the fuel system. Location: in front of fuel pump, inside fuel reservoir, inlet of each injector and inlet of fuel pressure regulator.

## **IDLE STABILIZATION VALVE**

Electronically controlled valve used to maintain idle speed at a pre-determined level by regulating intake air at idle. Location: rubber mounted to top of intake manifold and valve cover.



# Glossary/Component Location

---

## **INJECTOR**

Electronically activated valve which directs a cone-shaped mist of fuel into the intake port near each intake valve. Location: Mounted into the intake manifold at the cylinder head.

## **KNOCK SENSOR**

A piezoelectric crystal which generates a small voltage. This voltage signal is sent to the E.C.U. to correct ignition knock or detonation. Location: Next to No. 2 cylinder on engine block.

## **OXYGEN SENSOR**

Used to detect the amount of oxygen in the exhaust gases. Location: threads into catalytic converter housing on 105 hp. Threads into exhaust manifold on 100 hp.

## **PRESSURE REGULATOR**

A diaphragm type regulator used to maintain system pressure at a given value. Location: Bolted to left side of the fuel injector assembly.

## **RESIDUAL PRESSURE**

Fuel pressure in the fuel injection lines after the engine has been turned off.

## **TRANSFER PUMP**

Supplies the fuel pump reservoir with fuel from the tank. Location: Inside the fuel tank attached to the fuel tank sending unit.

## **THROTTLE SWITCH**

Provides closed throttle and full throttle signal to the E.C.U. for idle stabilization, deceleration fuel shut-off and full load enrichment. Location: Mounted to the throttle valve housing.



WE ENCOURAGE PROFESSIONALISM  
THROUGH TECHNICIAN CERTIFICATION